



**EVOTECH**®  
P E R F O R M A N C E

**Installation Instructions**

**DUCATI MONSTER 1200 and 821 - 2014 ONWARDS  
RADIATOR GUARD**

**Product Reference - 11674**

**Kit Contents**

- (A)** 1 x Radiator Guard
- (B)** 1 x Neoprene Foam

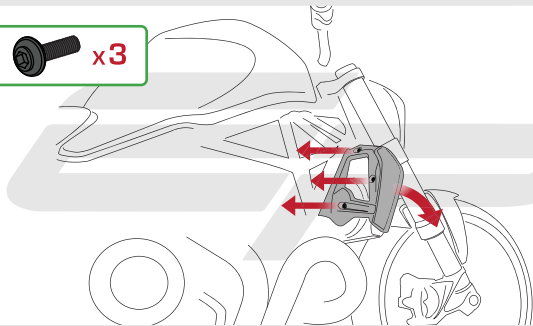

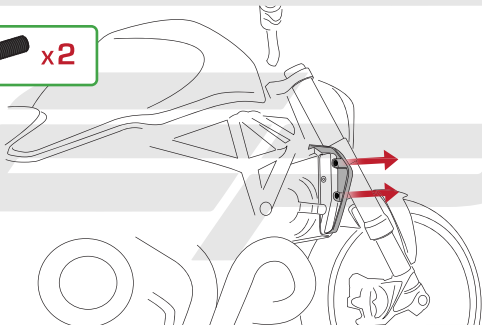

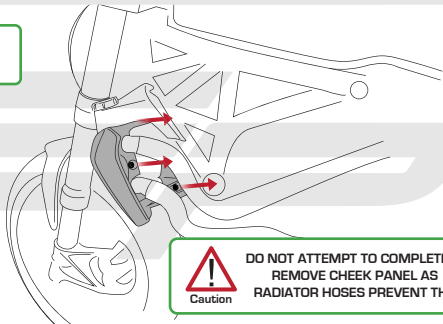

Caution

DO NOT ATTEMPT TO COMPLETELY  
REMOVE CHEEK PANEL AS  
RADIATOR HOSES PREVENT THIS

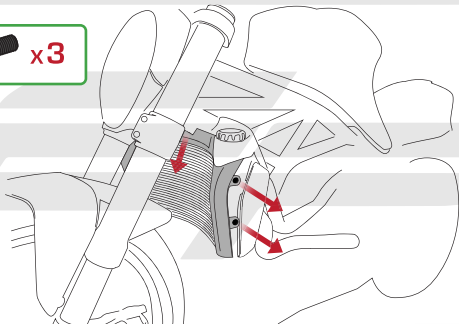

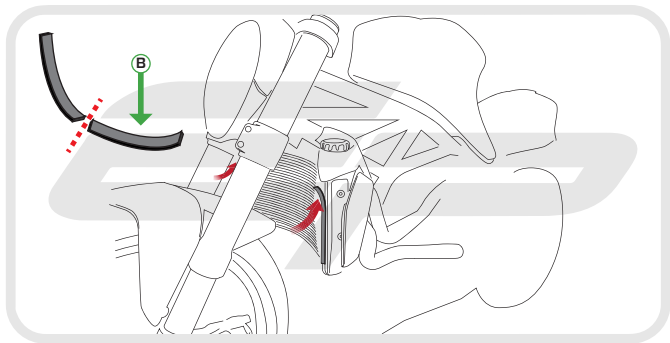

**EVOTECH**<sup>®</sup>  
P E R F O R M A N C E

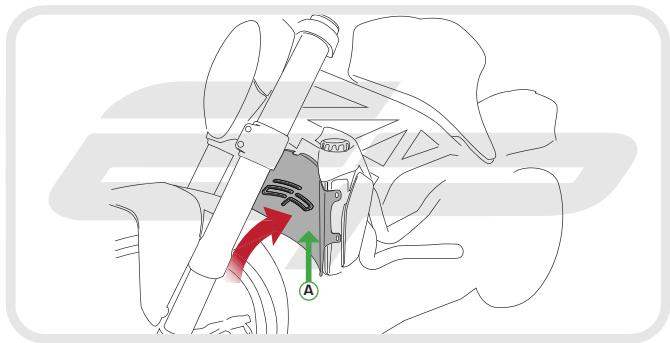

**EVOTECH**<sup>®</sup>  
P E R F O R M A N C E



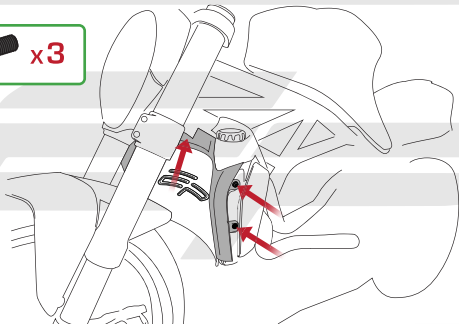



Reverse Stages

3, 2, 1



### Maintenance

It is recommended that periodic inspections are made to ensure that dirt and debris have not become trapped between the guard and the radiator/oil cooler. Such dirt and debris would reduce the cooling efficiency of the radiator/oil cooler



**EVOTECH**®  
P E R F O R M A N C E

[www.evotech-performance.com](http://www.evotech-performance.com)